

# ICT TODAY

THE OFFICIAL TRADE JOURNAL OF BICSI

April/May/June 2023

Volume 44, Number 2

**FAULT MANAGED POWER—  
A SAFE AND DISRUPTIVE  
INNOVATION FOR  
POWERING THE FUTURE**

**PLUS:**

- + POE Accelerates Smart Building Transformation in Heart of Manhattan
- + Scalable Passive Optical LAN Cabling Enabling Retrofit Installations

**Bicsi**<sup>®</sup>



# SCALABLE PASSIVE OPTICAL LAN CABLING ENABLING RETROFIT INSTALLATIONS

By John George

Passive optical LAN (POL) systems are a form of the passive optical network (PON) systems that have been deployed in fiber to the home (FTTH) builds to more than 700 million homes worldwide since the 1990s. Like PON systems, POL systems are now scalable to 10 Gb/s data rates with 25 Gb/s and 40 Gb/s on the horizon, to support forthcoming immersive bandwidth intensive applications such as virtual and augmented reality. Any POL optical cabling system installed today should be scalable to 10 Gb/s and higher data rates without signal degradation, while enabling reliable plug and play installation. These higher data rates are transmitted over longer wavelengths that increase bending loss by up to three times compared to gigabit systems. Advances in optical fiber and cabling developed and proven for FTTH deployments are now incorporated into compact, virtually invisible optical fiber cables in both the backbone and horizontal, ideal for retrofit POL or FTTH builds such as resorts, older, or historic buildings with limited or no available pathways and spaces.

## PASSIVE OPTICAL LAN COMPARED TO TRADITIONAL SWITCHED ETHERNET LAN SYSTEMS

A traditional enterprise architecture uses Ethernet switches connected by an optical fiber or category copper (typically Category 6 or Category 6A) backbone, and from the workgroup Ethernet switch ports a category copper cable will be routed to and connect an end point device such as a Wi-Fi router, video camera, computer, or any other device with an Ethernet port. The maximum reach of these category copper cables is 100 m (≈328 ft), resulting in the need for multiple switches configured in a star or mesh architecture to reach the end points in a medium or large area deployment. A POL system consists of an optical line terminal (OLT) port connected with a singlemode (SM) fiber to a passive splitter, which typically divides the signal into 32. From the splitter, the 32 SM fibers are placed to reach the end points. The maximum range of the POL system is 20 km (20,000 m, ≈65,617 ft), enabling very large enterprise deployments with no powered equipment between the main distribution frame (MDF) and the end points. A comparison of the POL and switched Ethernet architectures is shown to the right (Figure 1).

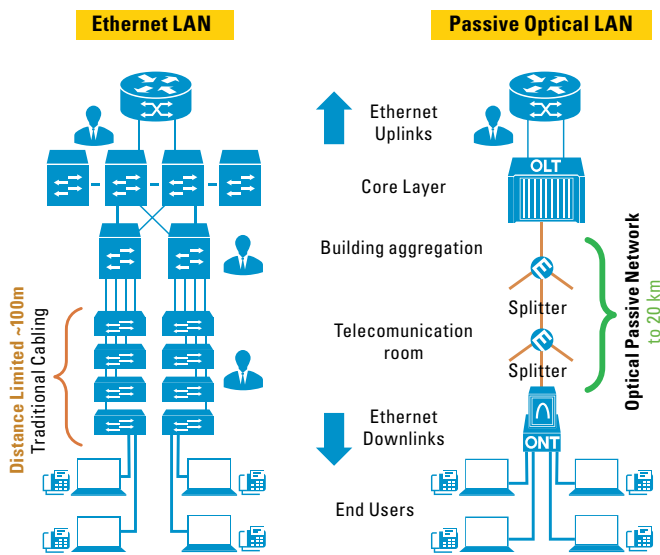
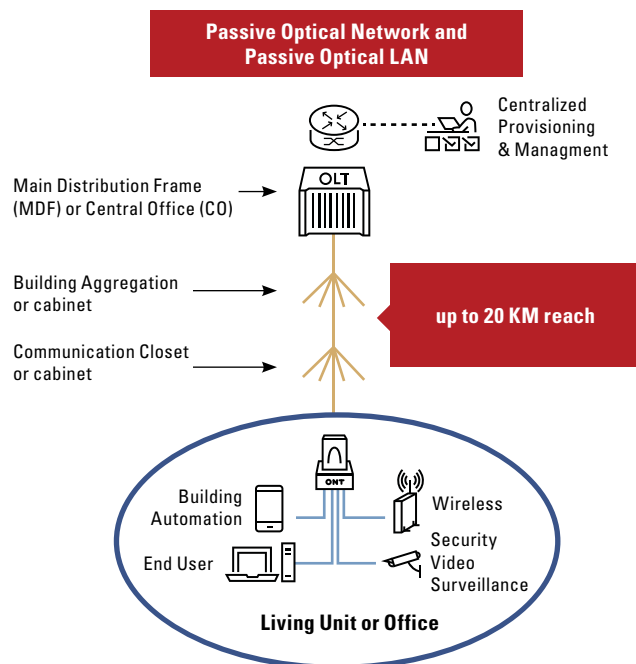

**FIGURE 1:** Ethernet LAN and Passive Optical LAN Architectures (Source: APOLAN).

### PASSIVE OPTICAL LAN USES THE SAME TECHNOLOGY PLATFORM AS FIBER TO THE HOME.

FTTH deployments have been using PON technology from the first trials in the 1990s through today. In the U.S., at the end of 2022, there were more than 60 million homes with FTTH services available and about 25 million connected by PON systems. PON systems use the same PON architecture as POL, with the addition of enterprise-grade security and operational/network management features. The physical and optical architectures of POL systems are the same as PON systems, as shown in Figure 2.

The optical cabling system for POL uses the same types of singlemode optical fiber cabling systems used for PON. The SC-UPC (ultra physical contact) connector, color-coded blue, has been used to plug into the optical line terminal (OLT) port since the earliest PON systems



**FIGURE 2:** Passive Optical Network and Passive Optical LAN Architecture.

dating back to the 1990s and has continued forward as the de-facto OLT connector standard in the industry. Within the optical distribution network (ODN) all the way to the optical network terminal (ONT), SC-APC (angled polish connectors) color-coded green became the standard due to the analog video signals carried on early PONs. Analog video can be degraded by optical power reflected back to the transmitter, but the angled end-face of SC-APC connectors reduces reflected power by  $\approx 10\text{--}20$  dB to effectively eliminate this degradation. Some ODNs use LC-APC connectors or multifiber push on (MPO) angled connectors, both again color-coded green, to fit in smaller spaces.

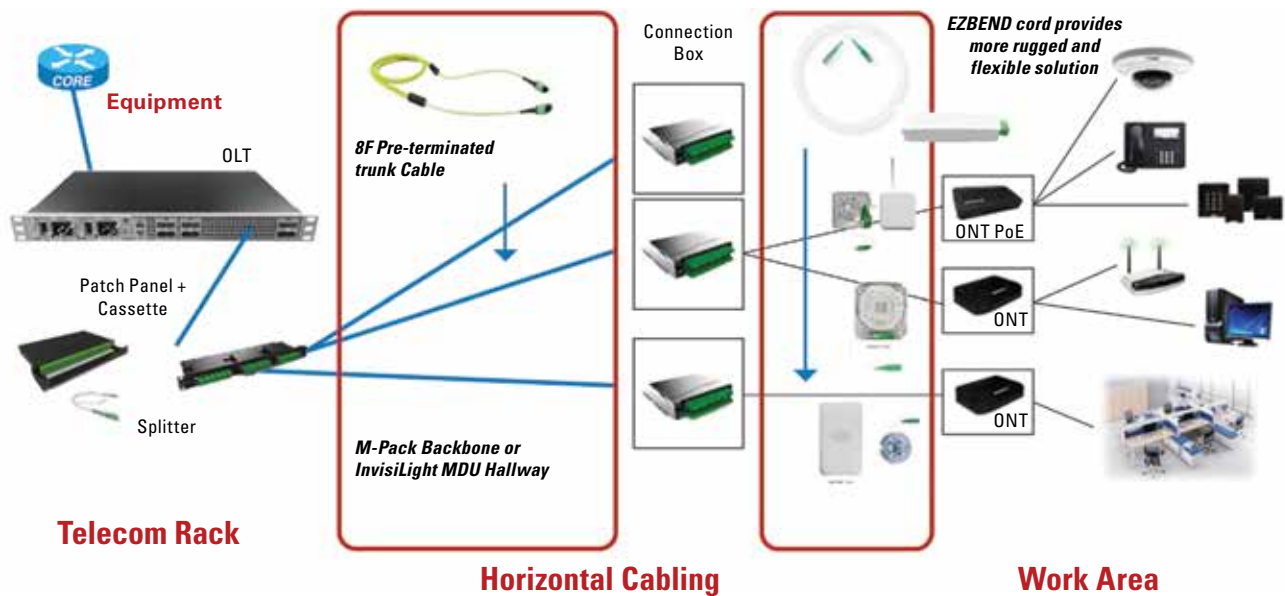

**FIGURE 3:** Passive Optical LAN Cabling Example.

An example of a POL optical cabling system is shown in Figure 3. In the MDF, an SC-UPC to SC-APC connectorized jumper connects an OLT port to a splitter inside a 1 RU shelf. The splitter divides the optical signal into 32 optical fibers terminated into four ports of eight fibers each. Each fiber backbone cable is compact in diameter (3 mm [ $\approx$ .12 in]) and contains eight singlemode bend insensitive optical fibers factory terminated with MPO angled connectors. Such a compact backbone cable can reduce space requirements by up to 80 percent compared to traditional optical cabling. The backbone cables are plugged into an MPO port of a local connection enclosure that fans out into single fiber SC-APC ports. From these ports there are various forms of ultra-bend insensitive optical cabling that can be routed to the ONT near the end points, and an SC-APC connectorized jumper can be plugged in to complete the ODN.

### RETROFIT INSTALLATIONS FACE CHALLENGES

Existing buildings, particularly older buildings, may not have proper pathways and spaces in place to accommodate and manage optical cabling. Existing pathways may be occupied or highly restricted in size. Pathways may have to be created by expensive and disruptive core drilling, or the installation of expensive and unsightly molding systems. The optimum placement of ONTs

to support Wi-Fi coverage may be in locations not served by conventional pathways. Additionally in some environments with customers or tenants present, a quick, hidden, and quiet installation is desired.

Surface mounting of optical fiber cabling along existing wall-to-ceiling interfaces, for example, is possible without the placement of a new pathway to reach most of any desired end point. However, this may require bending around very tight corners to maintain a tidy appearance, and a small bend radius not possible by conventional optical cables.

### 10 GB/S POL SYSTEMS AND BEND LOSS CONSIDERATIONS

The basic optical architecture POL uses two wavelengths on a single singlemode optical fiber to reach each optical network terminal as shown, using wavelength division multiplexing (WDM) to carry traffic in both directions simultaneously (Figure 4). There may be a single splitter or multiple splitters in series, and the loss of the splitters alone can reach 25 dB, leaving only 3 dB for fiber and connectors. Thus, added losses from bending can limit the reach or result in service disruptions.

PON and POL systems deployed since the mid-2000s have used either gigabit passive optical network (G-PON) systems as defined in the ITU-T G.984

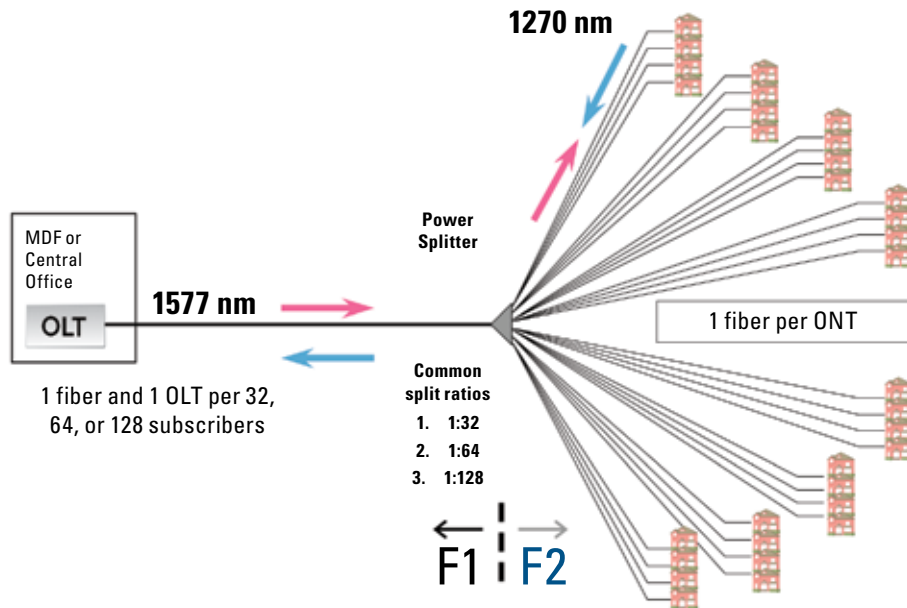

**FIGURE 4:** PON Optical Architecture, XGS-PON example shown.

recommendation, or gigabit Ethernet PON (GE-PON) systems as specified in the IEEE 802.3ah standard. For both of these systems, the wavelengths and transceiver types used are common, with the 1490 nm wavelength used to transmit data to the work area/living unit, and the 1310 nm wavelength used to transmit data from the work area/living unit. In response to increasing bandwidth demands, the leading equipment vendors developed and standardized XGS-PON systems as defined in the ITU-T G.987 recommendation. XGS-PON accounted for more than 50 percent of PON deployments in the U.S. in 2022 and is forecasted to be the predominate PON system

Moving from G-PON to XGS PON, for example, will increase the bending loss by up to 3X (Figure 5).

### ADVANCED OPTICAL FIBER CONFORMS TO SHARP CORNERS

Conventional singlemode optical fibers exhibit very high losses when bent around sharp corners in surface mount installations. The ITU-T G.652.D compliant fiber is rated to a minimum bend radius of 16 mm (≈.63 in) and is generally only used in outside plant (OSP) optical cables with very careful bend management. ITU-T G.657A1 fiber with its 10 mm (≈.39 in) minimum bend radius has become the standard in modern OSP cables

Application	Standard	Current Generation		Next Generation On Same Fiber Network		Bending Loss Increase
FTTH And Passive Optical LAN	IEEE	GE-PON Downstream	1490 nm	10G E-PON Downstream	1577 nm	3X
		G-PON Downstream		XGS-PON Downstream		
	ITU-T	40G-PON (NG-PON2)		1603 nm	4X	

**FIGURE 5:** Impact of longer wavelengths on bending loss.

deployed for the rest of the decade, according to research entity consultant firm Omdia.<sup>1</sup> Later systems are expected to use the 1577 nm and 1270 nm wavelengths, capable of 10 gigabit symmetrical data rates. Future systems such as NG-PON2 will use 1610 nm band wavelengths. Due to the physics of optical signal propagation in fibers, bending loss increases with longer wavelengths.

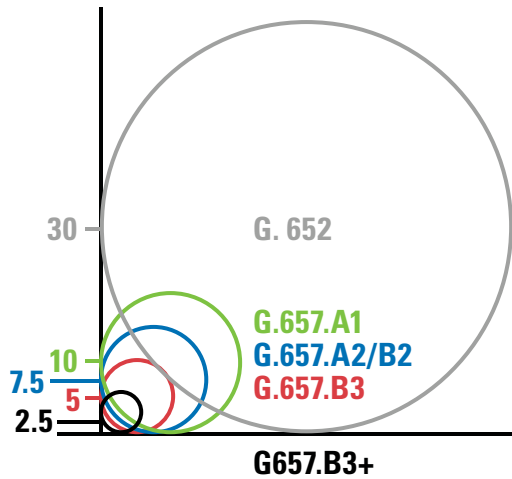

Uncabled Fiber Bend Loss (dB) vs. r2.5 mm corners			
1577 nm XGS-PON			
Corners	10	20	40
G.657.A2	10.0	20.0	40.0
G.657.B3	1.0	1.5	3.0
G.657.B3+	0.3	0.5	1.0

## POL RETROFIT SURFACE MOUNT CABLING OPTIONS

Combining the G.657.B3+ fiber with new low visibility cabling systems has revolutionized POL and FTTH optical fiber deployments in existing buildings. These technologies allow for stapling of 3 mm (≈.12 in) OD cables around sharp corners and surface mounting of 0.6 mm (≈.02 in) OD single fiber or 2 mm (≈.08 in) OD 12 fiber cables using a simple adhesive system, around sharp corners with unmanaged tight

**FIGURE 6:** Singlemode fiber grades and performance at 2.5 mm (≈.01 in) bend radius.

to tolerate inadvertent bending in splice trays, for example. At 7.5 mm (≈.29 in) bend radius, the ITU-T G.657A2 fibers are optimized for bend managed jumpers in patch panels or cabinets. ITU-G.657B3 fibers are rated to 5 mm (≈.2 in) minimum bend radius to allow stapling of relatively large OD cables around corners, with bend management essentially provided by the large cable OD limiting the fiber's minimum corner bend. There is also an ITU-T G.657.B3 compliant fiber available with a 2.5 mm (≈.1 in) minimum bend radius, which can support very tight conformal corner bends in very small OD cables down to 0.6 mm (≈.002 in) OD without bend management (Figure 6).

bends. More than 5 million residential and business subscribers have been connected to fiber broadband services with these cabling technologies since 2008 (Figure 7).

## RETROFIT HALLWAY FIBER SYSTEMS

When there is a surface available leading to the zone or work group area, it is possible to attach molding systems and then placing the optical fiber cabling into the molding as a second step. Molding systems may be attached by tape or screws and require custom onsite measuring and cutting to fit the many different lengths between corners. Masonry surfaces may not provide adequate adhesion with tape and require drilling pilot holes for fasteners.

### Ultra Bend-Insensitive Fiber with 2.5 mm Bend Radius



Installed cost savings of \$30 - \$60 per living unit, 50% faster install time using stapling and avoiding bend managers, molding or dry-wall cut and patch.

### Virtually Invisible Surface Mount Fiber (enabled by 2.5 mm bend radius fiber)



Installed cost savings of 50% - \$150 per living unit possible by avoiding expensive molding or drywall cut and patch. 50% faster install.

**FIGURE 7:** Two new technologies help extend optical fiber to living units and offices. Costs vary by region and country.

## CONVENTIONAL



- Very visible.
- Disrupts décor.
- Slow installation.

## VIRTUALLY INVISIBLE



- Preferred by building owners and tenants.
- Faster and easier to install.
- From MDF up the riser to each work area with no intermediate floor boxes.



**FIGURE 8:** Surface mount hallway systems.

Molding system installation requires the use of noisy tools such as saws and drills. Additionally, molding systems are visible and often not accepted by building owners. This is particularly true in hotels, MDUs, MTUs, historical buildings, or any environment where aesthetics are valued.

Another option is using a wet adhesive system to directly attach the optical cable to the surface. A very thin line of adhesive is placed in the crevice between walls and ceilings or walls and existing molding, and a small OD cable is pushed into the adhesive, which dries clear. White cables with 2 mm ( $\approx 0.08$  in) outer diameters attached in this manner are virtually invisible to the eye and preserve the existing décor. The tiny cables typically contain 12 color-coded optical fibers that can be accessed and terminated inside small surface mounted modules that branch optical fibers to reach end points. The cables contain 2.5 mm ( $\approx 0.1$  in) bend radius fibers so they can be bent around corners without management devices or bend loss concerns. Such systems are also available for outdoor deployments surface mounted on buildings or in outdoor hallways/breezeways. All the adhesive-attached cables contain aramid strength elements to allow pulling into compact riser spaces and down hallways, potentially eliminating the need for riser to horizontal transition enclosures (Figure 8).

## FIBER DROP CABLING TO THE END POINTS

From the backbone cabling, POL systems require a single fiber to reach each ONT, just like the PON systems supporting residential FTTH and businesses. As in the backbone deployment, limited pathways or ducts can limit cabling options, so surface mounting and conforming the cable to the building contours may be the lowest cost and least disruptive installation approach. Examples of ruggedized bend-insensitive single fiber cables shown here may be bent and stapled around sharp corners using single attachment methods without the need for any bend management (Figure 9). While these cables are intended to be stapled, the optical fiber cables that we typically use for premises cabling in general offices are not. ISO/IEC 14763-2 specifies that installation techniques shall not introduce deformation of the cable sheath. There is similar text in TIA-942.

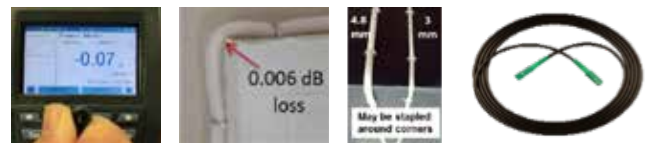

**FIGURE 9:** Drop cable to ONT examples with NEW r2.5 mm ruggedized bend-insensitive single fiber cables specifically designed to be bent and stapled around sharp corners using single attachment methods without the need for bend management.

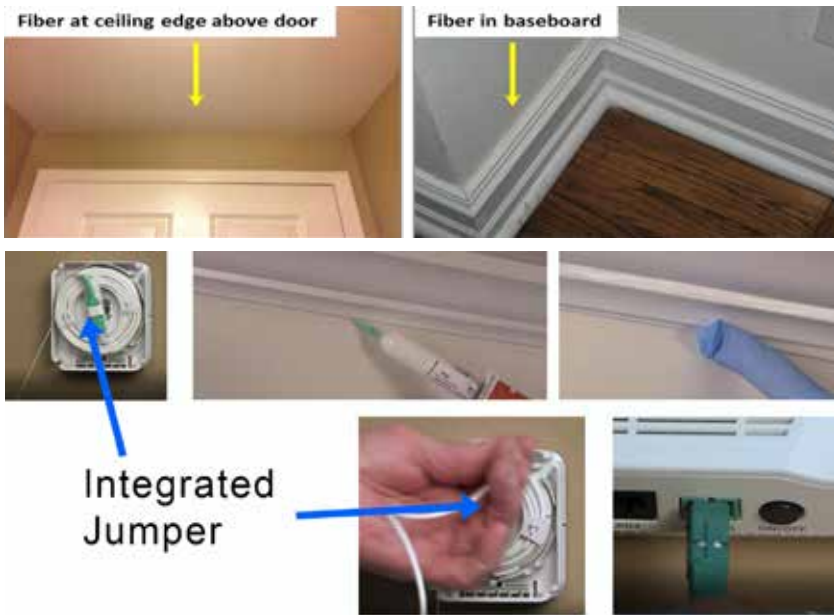

**FIGURE 10:** Single fiber to ONT, virtually invisible example.

Much smaller, virtually invisible drop fiber systems using the same wet adhesive process are also available. The 2.5 mm fiber is buffered to an O.D. of 0.6 or 0.9 mm ( $\approx 0.02$  or  $\approx 0.04$  in), factory terminated on both ends, and stored on a spool that spins within a module. The module is placed close to the ONT, and because the optical fiber can be routed to nearly any desired location by surface mounting, the ONT location can be optimized easily to reach end devices such as Wi-Fi access points, cameras, or other devices (Figure 10).

## CONCLUSION

POL systems should be scalable to 10 Gb/s and higher data rates without signal degradation, while enabling reliable plug and play installation. These higher data rates are transmitted over longer wavelengths that increase bending loss by three to four times compared

to gigabit systems. Advances in optical fiber and cabling developed and proven for FTTH deployments are now incorporated into compact, virtually invisible optical fiber cables in both the backbone and horizontal, ideal for retrofit POL or FTTH builds such as resorts, older, or historic buildings with limited or no available pathways and spaces.

## REFERENCE:

1. Kunstler, Julie. "The Growing and Expanding PON Market—A Significant Opportunity." OFC, 6 January 2023, [www.ofconfer-ence.org/en-us/home/news-and-press/ofc-blog/2022/december/the-growing-and-expanding-pon-market-%e2%80%93-a-significa](http://www.ofconfer-ence.org/en-us/home/news-and-press/ofc-blog/2022/december/the-growing-and-expanding-pon-market-%e2%80%93-a-significa).

**AUTHOR BIOGRAPHY:** John George has served with AT&T, Lucent Technologies, and now OFS in various engineering and marketing roles. He currently leads the Solutions Engineering and Fusion Splicer group for OFS's optical fiber, cable, connectivity, fusion splicer, and solutions business. John has published and presented numerous papers and articles on fiber optics and FTTH in numerous forums including the first 10 Gb/s multimode fibers at BICSI in 1999, and has been active in industry standards including IEEE and TIA. John has been supporting the Fiber Broadband Association (former FTTH Council) since 2001, served on its board of directors from 2008–2018, and he now leads the association's technology committee. John has a Bachelor of Mechanical Engineering from Georgia Tech and a Master of Science in engineering administration from Virginia Tech and holds 10 patents. John can be contacted at 770.314.0778 or johngeorge@ofsoptics.com.